

CALIFORNIA COASTAL COMMISSION

South Coast Area Office
200 OceanGate, Suite 1000
Newport Beach, CA 90802-4302
(562) 590-5071



Filed: 5/3/99
49th Day: 6/21/99
180th Day: 10/30/99
Staff: MV-LB
Staff Report: 5/20/99
Hearing Date: 6/8-11/99
Commission Action:

STAFF REPORT: REGULAR CALENDAR

APPLICATION NUMBER: 5-99-120

APPLICANT: Leroy C. Sutherland

AGENT: N.A.

PROJECT LOCATION: 1401 N Bay Front, Balboa Island (Newport Beach), Orange County

PROJECT DESCRIPTION: Construction of a new boat dock consisting of a 28 by 4 foot pier, 10 by 14 foot platform, 3 by 21 foot gangway, and 27 foot long float 4 feet wide at the channelward end with a 10 by 9 foot lobe at the base of the gangway. The pier and platform are proposed to be supported by three 14 inch square T-piles. The 10 by 14 foot platform is proposed to be used for staging area for boat passengers, especially small children, to prepare for boating excursions (i.e. put on life jackets, etc.), folding of sails and as a location for placement of fiberglass storage boxes to be used for storage of boating items such as anchors, fenders, and dock lines. In addition, because the platform is above the tide, it is a safe place to locate the weather tight electrical services necessary for the boat. Also, backflow devices are proposed to be mounted on the platform.

LOCAL APPROVALS RECEIVED: Newport Beach Fire and Marine Department Approval in Concept, Harbor Permit Number 151-1401.

SUBSTANTIVE FILE DOCUMENTS: City of Newport Beach Certified Land Use Plan, City of Newport Beach Harbor Permit Policies, Coastal Development Permits 5-98-523 (Bridges); 5-98-229 (Close).

SUMMARY OF STAFF RECOMMENDATION:

Staff recommends that the Commission approve the proposed project subject to one special condition which requires: minimization of construction impacts on harbor bottom and intertidal areas, appropriate storage of construction materials, removal of construction debris, and no mechanized equipment, except a barge or land-mounted crane, seaward of the bulkhead.

STAFF RECOMMENDATION:

The staff recommends that the Commission adopt the following resolution:

I. APPROVAL WITH CONDITIONS

The Commission hereby **GRANTS** a permit, subject to the conditions below, for the proposed development on the grounds that the development will be in conformity with the provisions of Chapter 3 of the California Coastal Act of 1976, will not prejudice the ability of the local government having jurisdiction over the area to prepare a Local Coastal Program conforming to the provisions of Chapter 3 of the Coastal Act, and will not have any significant adverse effects on the environment within the meaning of the California Environmental Quality Act.

II. STANDARD CONDITIONS:

1. **Notice of Receipt and Acknowledgment.** The permit is not valid and development shall not commence until a copy of the permit, signed by the permittee or authorized agent, acknowledging receipt of the permit and acceptance of the terms and conditions, is returned to the Commission office.
2. **Expiration.** If development has not commenced, the permit will expire two years from the date this permit is reported to the Commission. Development shall be pursued in a diligent manner and completed in a reasonable period of time. Application for extension of the permit must be made prior to the expiration date.
3. **Compliance.** All development must occur in strict compliance with the proposal as set forth in the application for permit, subject to any special conditions set forth below. Any deviation from the approved plans must be reviewed and approved by the staff and may require Commission approval.
4. **Interpretation.** Any questions of intent or interpretation of any condition will be resolved by the Executive Director or the Commission.
5. **Inspections.** The Commission staff shall be allowed to inspect the site and the project during its development, subject to 24-hour advance notice.
6. **Assignment.** The permit may be assigned to any qualified person, provided assignee files with the Commission an affidavit accepting all terms and conditions of the permit.
7. **Terms and Conditions Run with the Land.** These terms and conditions shall be perpetual, and it is the intention of the Commission and the permittee to bind all future owners and possessors of the subject property to the terms and conditions.

III. SPECIAL CONDITIONS

1. Storage of Construction Materials, Mechanized Equipment and Removal of Construction Debris

Disturbance to the harbor bottom and intertidal areas shall be minimized. The applicant agrees not to store any construction materials, oils or liquid chemicals or other waste where it is subject to wave erosion and dispersion into the harbor waters. The applicant shall remove from the beach, bulkhead and dock area any and all debris resulting from the removal of the existing dock and the construction of the new dock. No mechanized equipment, with the exception of a barge or land-mounted crane, is allowed seaward of the bulkhead at any time.

IV. FINDINGS AND DECLARATIONS:

The Commission hereby finds and declares:

A. Project Description and Location

The applicant proposes to construct a new boat dock consisting of a 28 by 4 foot pier, 10 by 14 foot platform, 3 by 21 foot gangway, and 27 foot long float 4 feet wide at the channelward end with a 10 by 9 foot lobe at the base of the gangway. The pier and platform are proposed to be supported by three 14 inch square T-piles. The 10 by 14 foot platform is proposed to be used for staging area for boat passengers, especially small children, to prepare for boating excursions (i.e. put on life jackets, etc.), folding of sails and as a location for placement of fiberglass storage boxes to be used for storage of boating items such as anchors, fenders, and dock lines. In addition, because the platform is above the tide, it is a safe place to locate the weather tight electrical services necessary for the boat. Also, backflow devices are proposed to be mounted on the platform.

The subject site is located on Balboa Island in Newport Harbor. Balboa Island is not a private community. Public access exists along the public walkway which circles the entire perimeter of Balboa Island. The subject site is adjacent to the Balboa Island bridge.

B. Marine Environment

Section 30233 of the Coastal Act states, in pertinent part:

(a) The diking, filling, or dredging of open coastal waters, wetlands, estuaries, and lakes shall be permitted in accordance with other applicable provisions of this division, where there is no feasible less environmentally damaging alternative, and where feasible mitigation measures have been provided to minimize adverse environmental effects, and shall be limited to the following:

(4) In open coastal waters, other than wetlands, including streams, estuaries, and lakes, new or expanded boating facilities and the placement of structural

pilings for public recreational piers that provide public access and recreational opportunities.

In addition, the City's certified Land Use Plan states:

Residential and commercial structures (except piers and docks used exclusively for berthing of vessels) shall not be permitted to encroach beyond the bulkhead line.

The Coastal Act limits the fill of open coastal waters. Section 30233 of the Coastal Act allows fill of open coastal waters, such as Newport Harbor, for recreational boating purposes. The proposed project requires piles, which constitute fill. The piles necessary to support the proposed pier, gangway and float are allowable because they are necessary to support a recreational boating facility. The project proposes to use T-piles to support the pier and platform. Because the platform is a widened area of the pier, the same number of T-piles would be required to support the pier with or without the platform. Therefore, no fill is required for the support of the platform. Nevertheless, the question has arisen of whether or not the proposed 10 by 14 foot platform constitutes a bona fide boating use or would serve as private residential patio area. The City's certified Land Use Plan (LUP) policy cited above precludes residential and commercial structures (except piers and docks used exclusively for berthing of vessels) from encroaching beyond the bulkhead line.

Existing private, residential boating facilities in Newport Harbor often consist of a pile-supported pier with platform area, a gangway, and a rectangular or "U" shaped float. The City's Harbor Permit Policies limit the size of the platforms to 10 by 14 feet. Piers are fixed, pile-supported structures which extend from dry land areas to water areas connecting to a gangway which leads to a float. The length of a pier depends on the size of the boat, the amount of draft the boat needs, and the depth of the water. The overall length of a boat dock is limited by the City's Harbor Permit Policies (HPP). The HPP do not allow docks to extend channelward of the adjudicated U.S. Pierhead Line, except in certain specified areas where, due to the bottom configuration and/or the width of the channel, they are allowed to extend to the adjudicated U.S. Project Line.

The piers and gangways are typically 3 to 4 feet wide. The docks or floats vary in size and configuration depending largely upon the type and size of boat to be docked. The majority of boat docks in Newport Harbor have platforms. Based upon a site visit, review of aerial photos of the harbor, conversations with the Newport Beach Fire and Marine Safety Department staff, and review of prior waivers and coastal development permits, Commission staff confirmed the approval of several platforms. Commission staff observed that while some of the existing platforms in Newport Harbor contained lockers, small boats, kayaks, and boating equipment or were empty, others had tables and chairs or benches, flower pots, etc. Staff also observed that while some of the platforms were supported by pilings at each corner, other platforms and piers were supported by a single row of "T" shaped piles.

The applicant has indicated that the platform will be used solely for boating purposes. More specifically the proposed uses of the 10 by 14 foot platform include use as an area for folding sails, a staging area where boat passengers, especially small children, may safely prepare for boating excursions (i.e. put on life jackets, etc.), and as a location for placement of fiberglass storage boxes to be used for storage of boating items such as lifejacket, tool box, sails, sail

bags, tillers, rudders, paddles, and boat covers. In addition, because the platform is above the tide, it is a safe place to locate the weather tight electrical services necessary to serve the boat. Also backflow devices would be mounted on the platform. Based on the uses proposed by the applicant, the Commission finds that the proposed platform does constitute a boating facility. As a boating facility, the proposed platform is a use specifically allowed under Section 30233(a)(4) of the Coastal Act.

Section 30233 also requires that any project involving fill of open coastal waters, in addition to being an allowable use, must also be the least environmentally damaging feasible alternative. One way to reduce environmental damage is to minimize the amount of fill. Some platforms in Newport Harbor have been constructed using two T-piles centered under the platform area rather than a single pile at each of the four corners. Although the T-piles have a slightly larger diameter than the single piles, the use of two T piles rather than four single piles results in less fill. In addition, the project has been designed in conformance with the Department of Boating and Waterways Guidelines, and uses only the piles necessary to support recreational boating facilities. Therefore, the Commission finds that as proposed the design of the project, including the platform, is the least environmentally damaging feasible alternative.

Section 30233 also requires that any project which results in fill of open coastal waters also provide adequate mitigation. The proposed project meets this requirement because the pilings provide habitat for marine organisms. Therefore, the Commission finds that the proposed project is consistent with Section 30233 of the Coastal Act.

C. Public Access and Recreation

Section 30604(c) of the Coastal Act requires that every coastal development permit issued for any development between the nearest public road and the sea includes a specific finding that the development is in conformance with the public access and recreation policies of Chapter 3 of the Coastal Act. The proposed development is located between the sea and the first public road.

Section 30212 of the Coastal Act states, in relevant part:

- (a) Public access from the nearest public roadway to the shoreline and along the coast shall be provided in new development projects except where:
 - (2) adequate access exists nearby.

Section 30224 of the Coastal Act states:

Increased recreational boating use of coastal waters shall be encouraged, in accordance with this division, by developing dry storage areas, increasing public launching facilities, providing additional berthing space in existing harbors, limiting non-water-dependent land uses that congest access corridors and preclude boating support facilities, providing harbors of refuge, and by providing for new boating facilities in natural harbors, new protected water areas, and in areas dredged from dry land.

Sections 30210, 30211 and 30212 of the Coastal Act require that new development provide maximum public access and recreation, not interfere with the public's right of acquired access, and provide public access from the nearest public roadway to the shoreline and along the coast except under certain

circumstances. The subject site is located on Balboa Island in Newport Harbor. Balboa Island is not a private community. Public access exists along the public walkway which circles the entire perimeter of Balboa Island.

The proposed development consists of construction of a new boat dock. The proposed development will not adversely impact navigation. The development will not create adverse impacts on coastal access and recreation. The proposed boat dock will not interfere with the public's continued use of the adjacent public walkway. Therefore, the Commission finds that the proposed development does not pose significant adverse impacts on existing public access and recreation and is consistent with Section 30212 of the Coastal Act.

In addition, the proposed development is a recreational boating facility. Recreational boating facilities are an encouraged use under Section 30224 of the Coastal Act. Therefore, the proposed development is consistent with Section 30224 of the Coastal Act.

D. Water Quality

Section 30230 of the Coastal Act states:

Marine resources shall be maintained, enhanced, and where feasible, restored. Special protection shall be given to areas and species of special biological or economic significance. Uses of the marine environment shall be carried out in a manner that will sustain the biological productivity of coastal waters and that will maintain healthy populations of all species of marine organisms adequate for long-term commercial, recreational, scientific, and educational purposes.

The project site is on the water in Newport Harbor. The applicant is proposing to construct a new recreational boating facility. The approval from the City of Newport Beach indicates that no eelgrass is present at the site.

Because the development is located on the water there is the possibility that materials from construction may end up in the harbor waters. In order to prevent adverse impacts to marine waters from construction and demolition, special condition 1 provides for the safe storage of construction materials and the disposal of demolition end products.

Only as conditioned for appropriate storage of construction materials and equipment does the Commission find that the proposed development is consistent with Section 30230 of the Coastal Act.

E. Local Coastal Program

Section 30604(a) of the Coastal Act provides that the Commission shall issue a coastal permit only if the project will not prejudice the ability of the local government having jurisdiction to prepare a Local Coastal Program which conforms with Chapter 3 policies of the Coastal Act.

The Commission certified the Land Use Plan for the City of Newport Beach on May 19, 1982. As conditioned, the proposed development is consistent with the policies contained in the certified Land Use Plan and with the Chapter 3 policies of the Coastal Act. Therefore, approval of the proposed development will not prejudice the City's ability to prepare a Local Coastal Program for Newport Beach that is consistent with the Chapter 3 policies of the Coastal Act as required by Section 30604(a).

F. Consistency with the California Environmental Quality Act

Section 13096 of Title 14 of the California Code of Regulations requires Commission approval of Coastal Development Permits to be supported by a finding showing the amendment to the coastal development permit, as conditioned by any conditions of approval, to be consistent with any applicable requirements of the California Environmental Quality Act (CEQA). Section 21080.5(d)(2)(A) of CEQA prohibits a proposed development from being approved if there are feasible alternatives or feasible mitigation measures available which would substantially lessen any significant adverse effect which the activity may have on the environment.

The proposed project has been conditioned in order to be found consistent with the marine resource protection policies of Section 30230 of the Coastal Act. Mitigation measures, in the form of a special condition requires removal of construction debris and minimization of construction impacts, will minimize all adverse effects. As conditioned, there are no feasible alternatives or feasible mitigation measures available, beyond those required, which would substantially lessen any significant adverse effect which the activity may have on the environment. Therefore, the Commission finds that the proposed project, as conditioned to mitigate the identified effects, is the least environmentally damaging feasible alternative and can be found consistent with the requirements of the Coastal Act to conform to CEQA.

5-99-120

Exhibit A
Vicinity Map
5-99-120

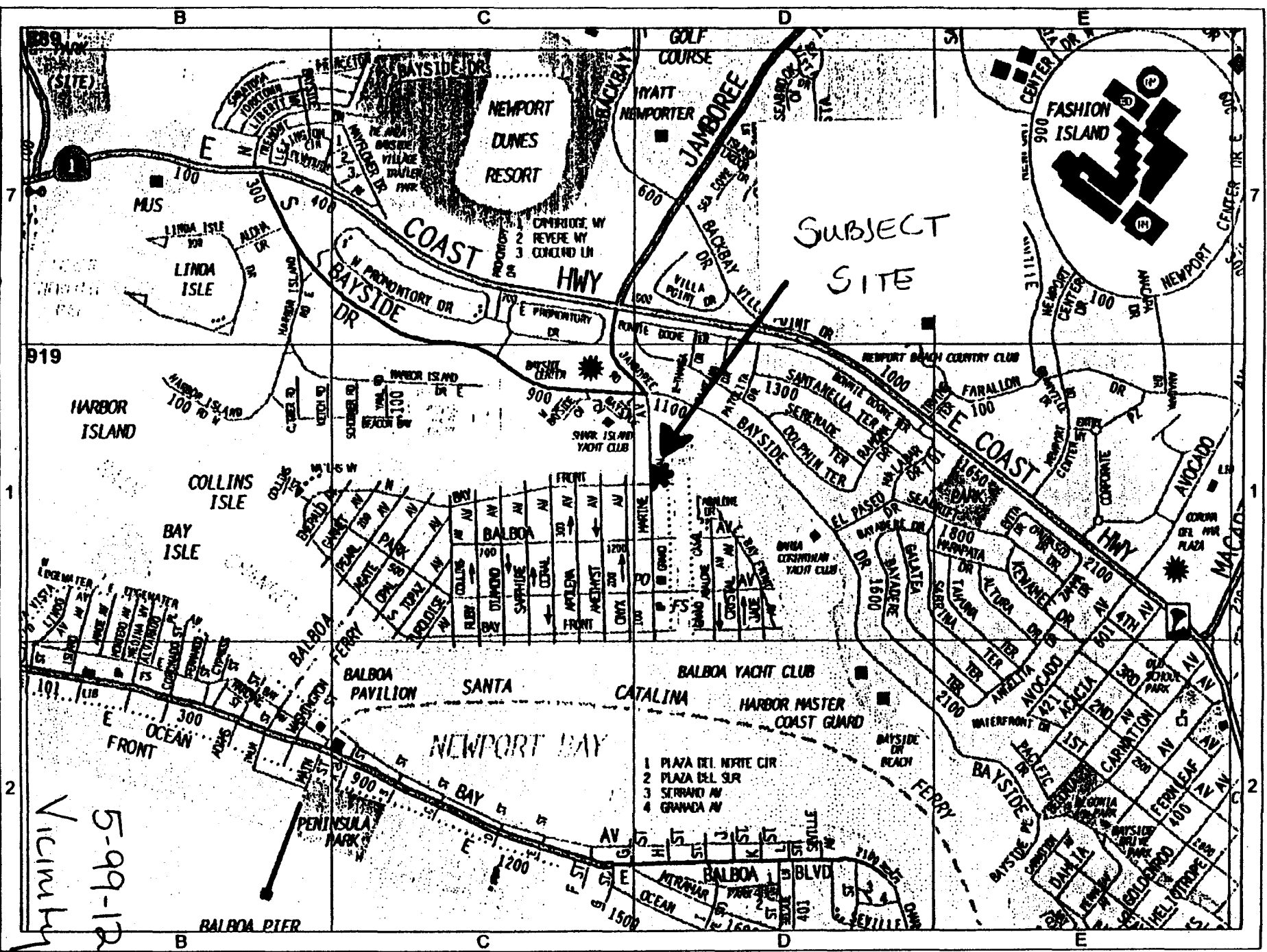

- 1 PLAZA DEL NORTE CIR
- 2 PLAZA DEL SUR
- 3 SERIANO AV
- 4 GRANADA AV

5-99-120

MARCH 1999

38

39

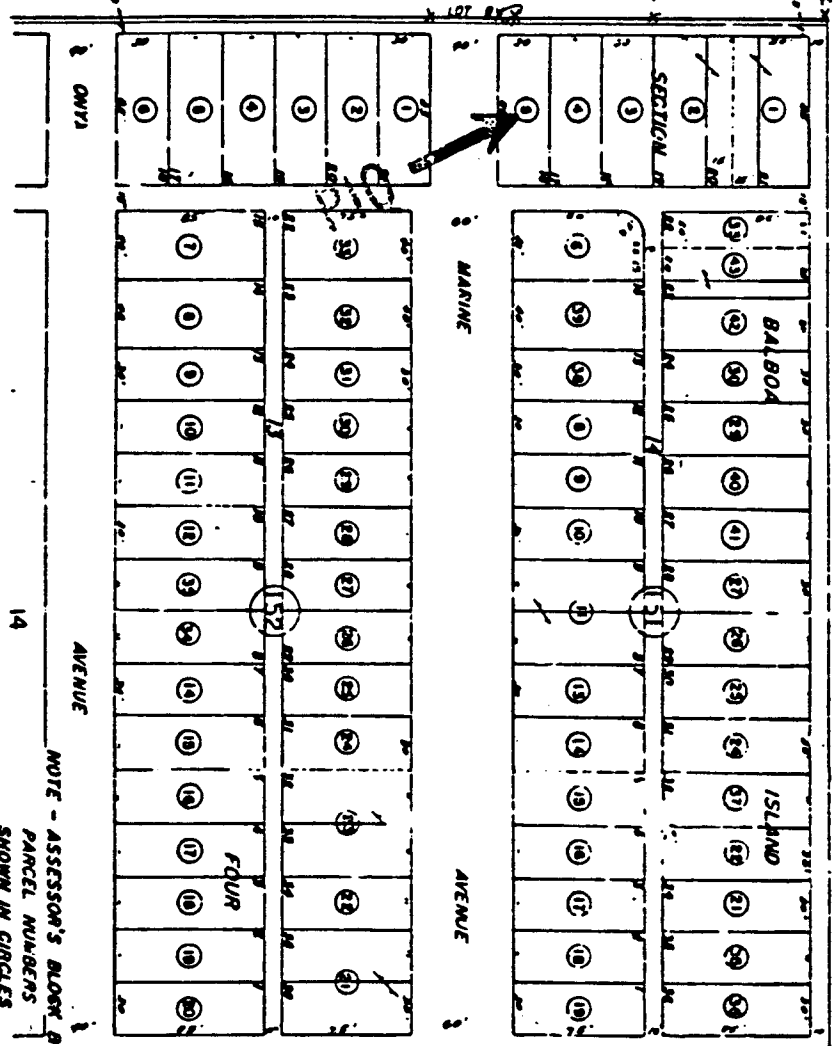

NOTE - ASSESSOR'S BLOCK & PARCEL NUMBERS SHOWN IN CIRCLES

ASSESSOR'S MAP BOOK 50 PAGE 18 COUNTY OF ORANGE

LOT 16,
IN BLOCK 14,
OF SECT 4,
BALBOA ISLAND

RECEIVED
South Coast Region
MAR 26 1999
CALIFORNIA
COASTAL COMMISSION

50-15

Furnished merely as a convenience to aid you in locating the land indicated herein with reference to streets and other land. No liability is assumed by reason of any reliance hereon.

Assessor's Parcel Map 5-99-120
Exhibit B

ATTACHMENTS, REVA.
5/3/99

SCALE: 1" = 5'

PLAN VIEW

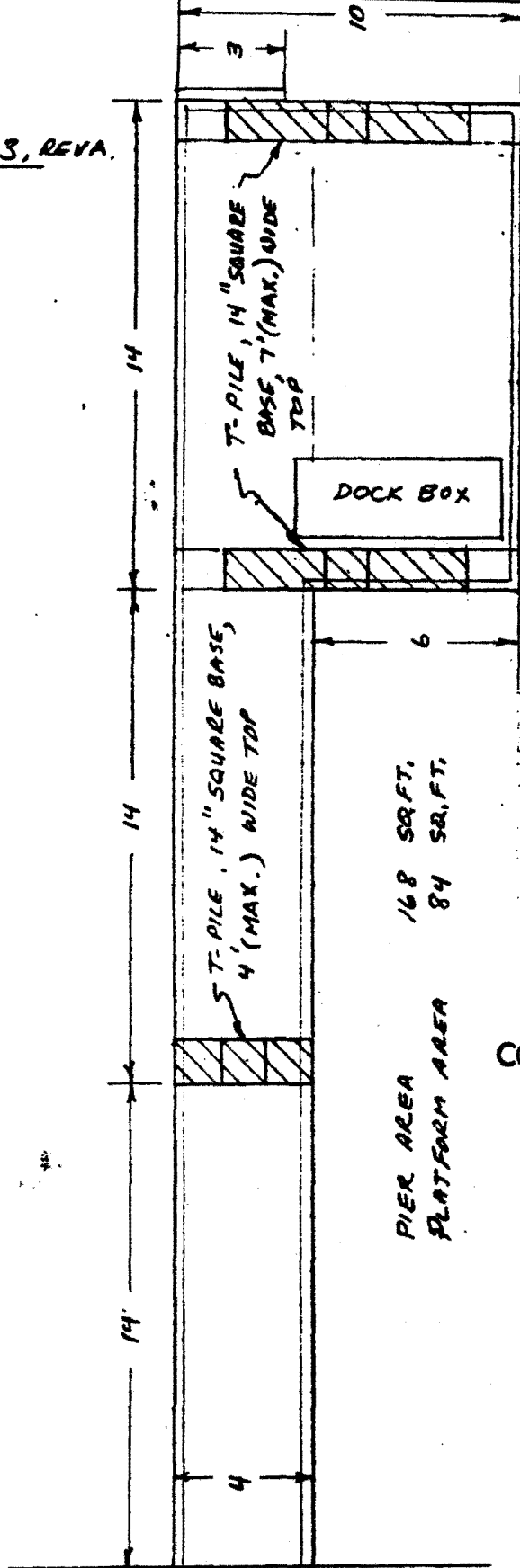

RECEIVED
 South Coast Region
 MAY 6 1999
 CALIFORNIA
 COASTAL COMMISSION

ELEVATION

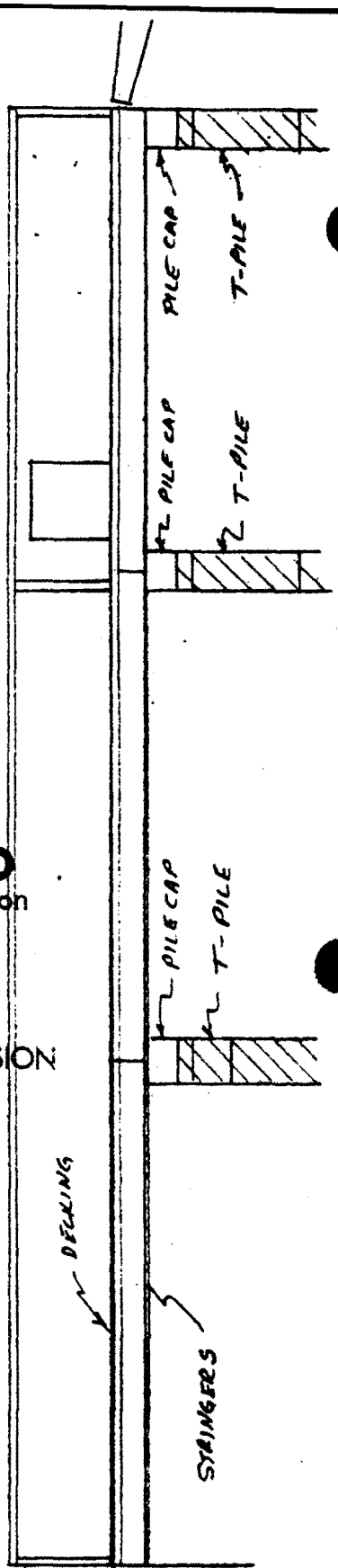

Proposed Dock

5-99-120

Exhibit

C

5/3/99

ATTACHMENT 1, P. 2, REV. A.

RECEIVED
South Coast Region
MAY 6 1999
CALIFORNIA
COASTAL COMMISSION

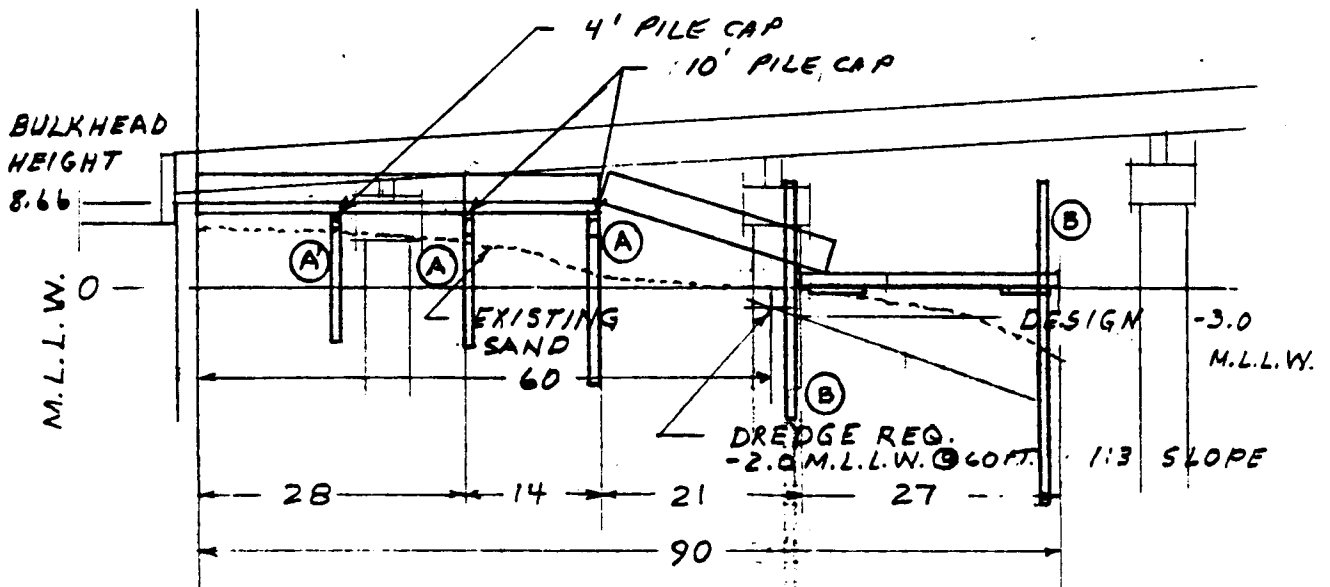

PILES:

- (A) 1 - T-PILE, 14 INCH SQUARE BASE, 4' (MAX.) WIDE TOP
- (A) 2 - T-PILES, 14 INCH SQUARE BASE, 7' (MAX.) WIDE TOP
- (B) 2 - 12 INCH SQUARE STRAIGHT PILES

SCALE: 1" = 20'

Proposed Dock
X-Section

5-99-120
Exhibit D

ATTACHMENT I, P.I., REV A

PROP LINE

PROP LINE



5-99-120

EXHIBIT

5/3/99
SCALE 1" = 20'

B.I. BRIDGE

U.S. PIERHEAD LINE

U.S. PROTECT LINE

NOTES:

1. AREA CALCULATIONS -
PIER 168 SQ. FT.
PLATFORM 84 SQ. FT.
GANWAY 72 SQ. FT.
DOCK 167 SQ. FT.
2. PILES
(A) 1 - T-PILE, 14 INCH SQUARE BASE, 4' (MAX.) WIDE TOP
(A) 2 - T-PILES, 14 INCH SQUARE BASE, 7' (MAX.) WIDE TOP
(B) 2 - 12 INCH SQUARE STRAWNT PILES

RECEIVED
MAY 6 1999
South Coast Region
CALIFORNIA COASTAL COMMISSION

proposed dock and Balboa Island Bridge

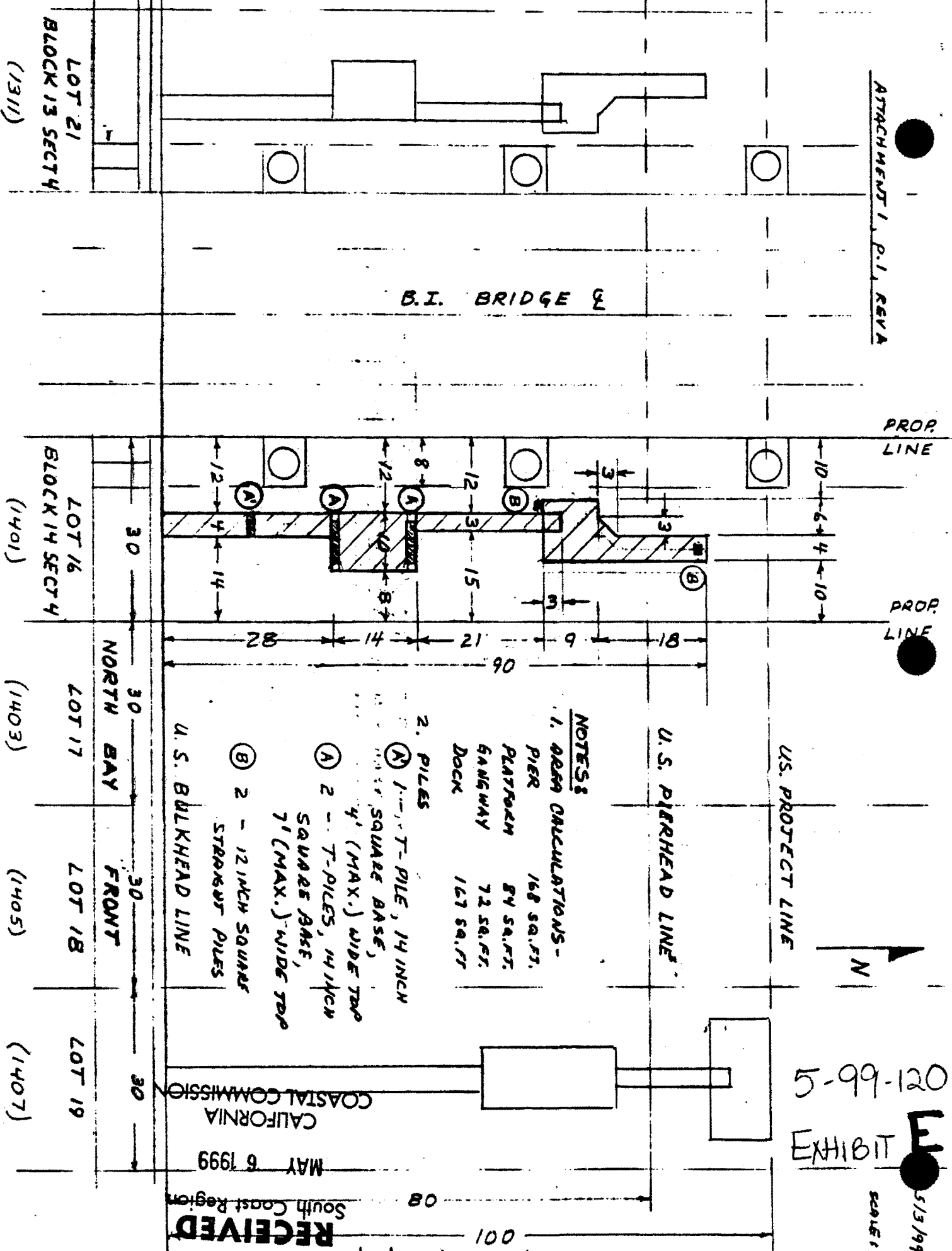

13 A

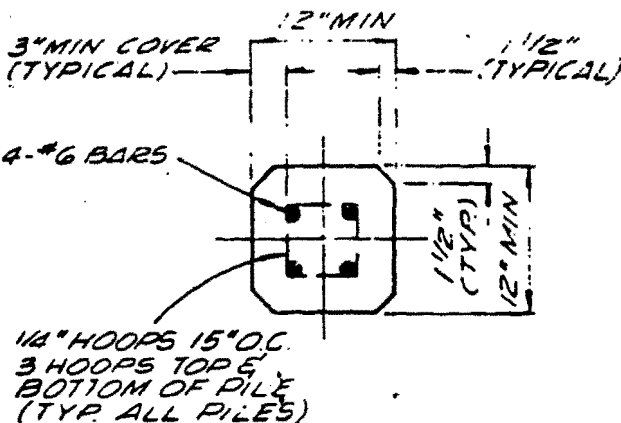

TYPE "A" PILE
SCALE: 3/4" = 1'-0"

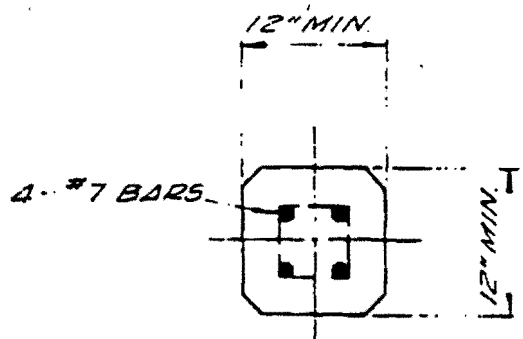

TYPE "B" PILE
SCALE: 3/4" = 1'-0"

1/4" HOOPS 15" O.C.
3 HOOPS TOP &
BOTTOM OF PILE
(TYP. ALL PILES)

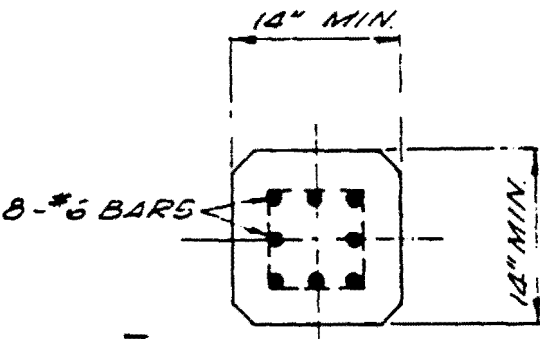

TYPE "C" PILE
SCALE: 3/4" = 1'-0"

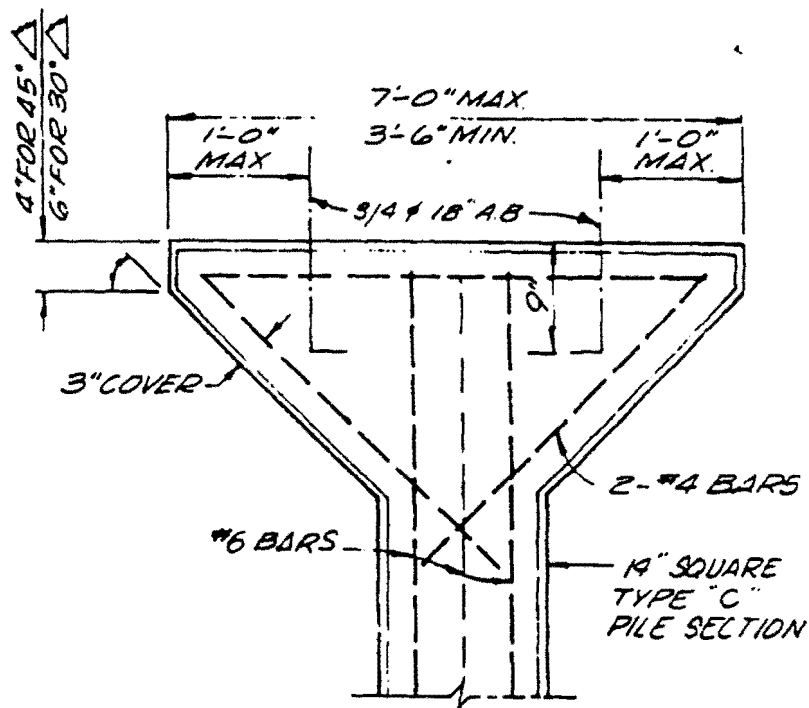

TYPE "D" PILE
SCALE: 3/4" = 1'-0"

NOTE: ALL PILING SHALL BE 560-C-3250 CONCRETE

RECEIVED
South Coast Region

MAY - 3 1999

CALIFORNIA
COASTAL COMMISSION

5-99-120

REV 4 8 85
REV 9-2-78

CITY OF NEWPORT BEACH
PUBLIC WORKS DEPARTMENT

DRAWN A.L. DATE 3-1-73

APPROVED J.T. Deulin
PUBLIC WORKS DIRECTOR
R.E. NO. 9537

PILE DETAILS

Typical T-Pile X-Sec.

DRAWING NO. **STD-610-L**

EXHIBIT F

SAM F. KNISS
CONSULTING CIVIL ENGINEER
C-17377
19 AGATE
IRVINE, CA. 92614
(949) 733-8430

April 26, 1999

Lora Vance
1311 North Bay Front
Balboa Island, Ca. 92662

RE: PIER CONSTRUCTION

Dear Mrs. Vance;

In response to your questions regarding pier construction, please review the following:

1. For the past 20 plus years, piers have been supported on 12" square prestressed concrete pile. The piles are set in pairs for the approach walkway and at the bayward end the piles are simply set further apart to provide the support for the larger (10'x14') platform. The platforms are used for storage of life vests and boat gear. The platforms are also used as a holding area for boat passengers and for passengers to put on their life vests. T-head pile offer an acceptable solution. A single T-head pile can replace a pair of straight piles, however, the accepted size is 14" square rather than the 12" square for the straight pile. The cross-sectional area of the straight pile is 0.97 sq. ft., while the area of the T-head pile is 1.33 sq. ft. Although prestressed concrete pile can support a greater load, T-head piles are more than adequate for this application.
2. Accepted engineering design practice dictates that the span between the piles should be between 12' and 16' and not more than 18'. If the span is greater than 18', the load on the piles becomes quite large and causes some design problems. Also with long spans, sagging of the stringers occurs and the pier has a springing reaction with foot traffic and raises safety issues.

I trust the above answers your questions but should you have any questions, feel free to contact me at any time.

Sincerely,

Sam F. Kniss

Engineer's Assessment
of
Viability of T-pile Use

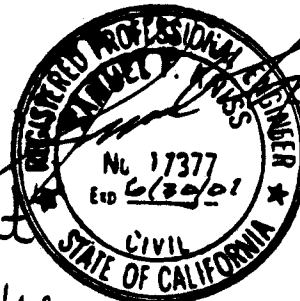

Exhibit **G**

RECEIVED
South Coast Region
MAY - 3 1999
CALIFORNIA
COASTAL COMMISSION

ATTACHMENT 4 PIER PILE FOOTPRINTS

SCALE: 1" = 10'

NOTE: FOR APPL # 5-99-12, THE PLATFORM IS REVERSED

A. USING STRAIGHT PILES

1. WITHOUT PLATFORM

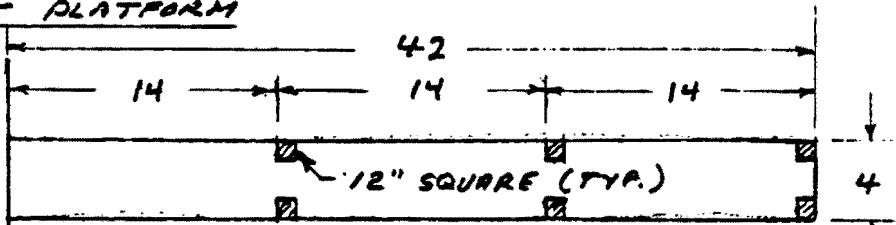

PIER PILE OCCUPIED AREA = 6×0.97
= 5.82 SQ. FT.

2. WITH PLATFORM

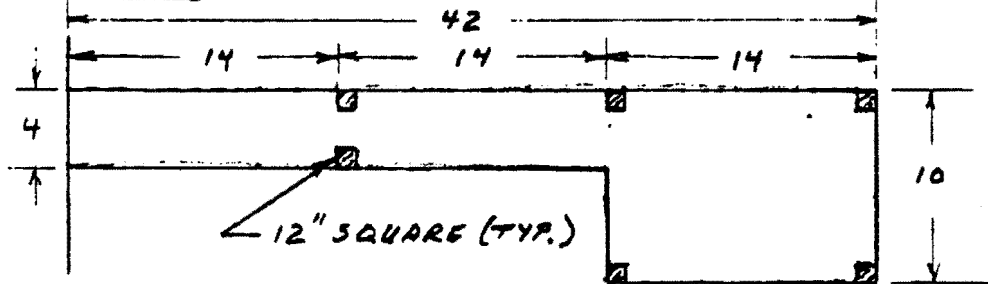

PIER/PLATFORM PILE OCC. AREA = 5.82 SQ. FT.
(NO CHANGE)

B. USING T-PILES

1. WITHOUT PLATFORM

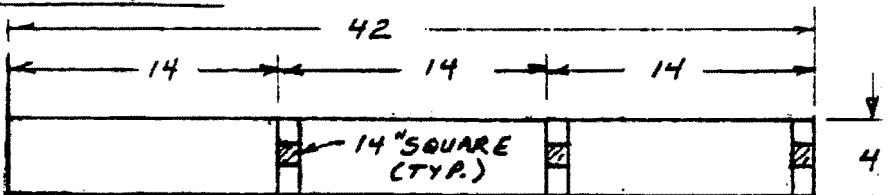

PIER PILE OCCUPIED AREA = 3×1.33
= 3.99 SQ. FT.

2. WITH PLATFORM

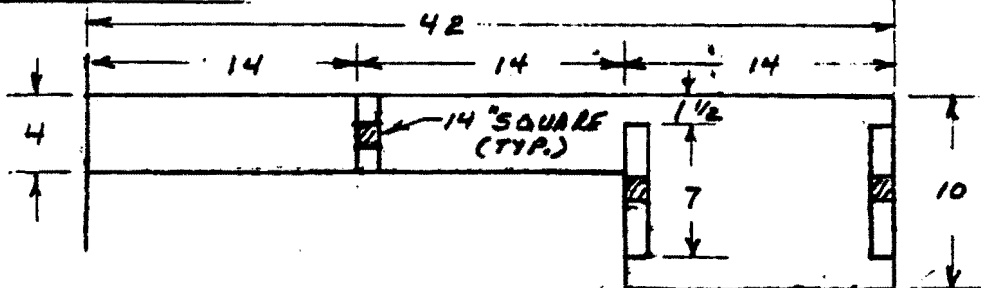

PIER/PLATFORM PILE OCC. AREA = 3.99 SQ. FT.
(NO CHANGE)

RECEIVED
South Coast Region

MAY - 3 1999

CALIFORNIA
COASTAL COMMISSION

NOTE:

5-99-120

Exhibit

DOCK (FLOAT) PILES ARE 0.97 SQ. FT. EACH, FOR AN ADDITIONAL 1.94 SQ. FT. FOR EACH CASE. THE TOTAL AREA IS THEREFORE 7.76 SQ. FT. FOR THE STRAIGHT PILES AND 5.93 SQ. FT. FOR THE T-PILES. THE DIFFERENCE IS 1.83 SQ. FT.

92

1

2

3